

MEDOS HILITE® LT

*Oxygenator for the extended application
for Adults, Paediatrics and Infants*

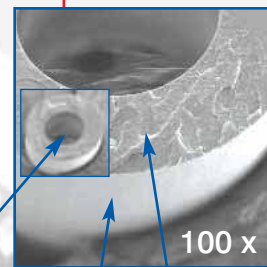

100 x

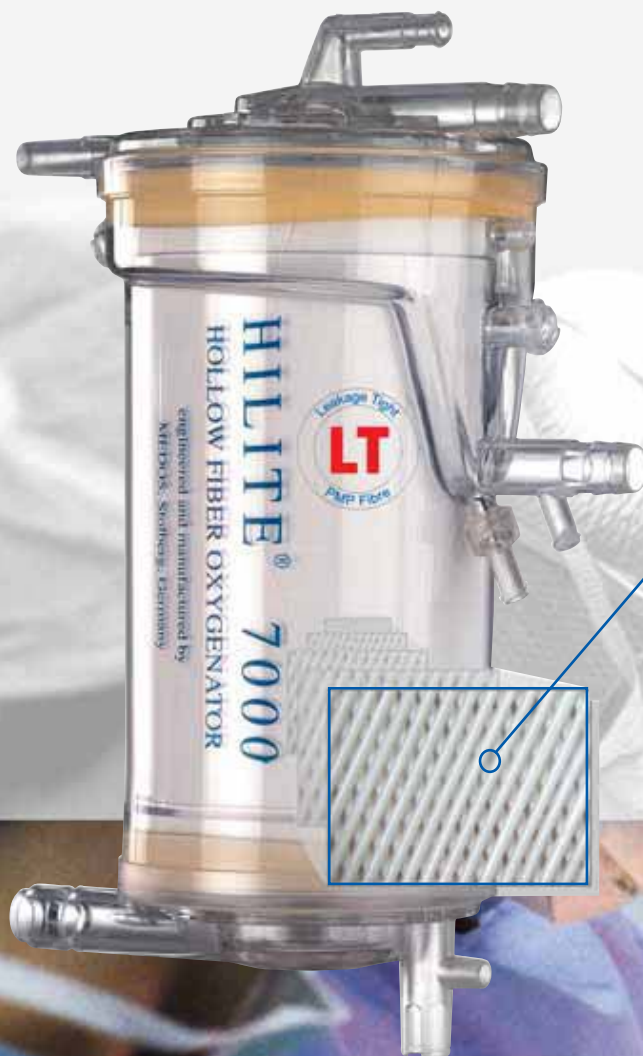
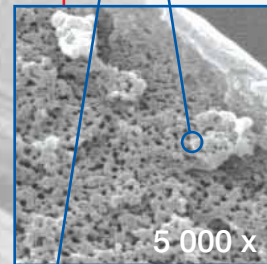

5 000 x

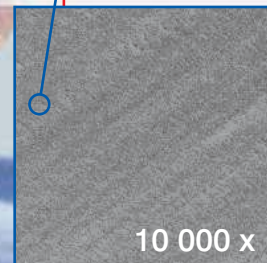

10 000 x



MEDOS HILITE® 7000 LT

Hollow Fibre Oxygenator with Diffusion Membrane for Adults

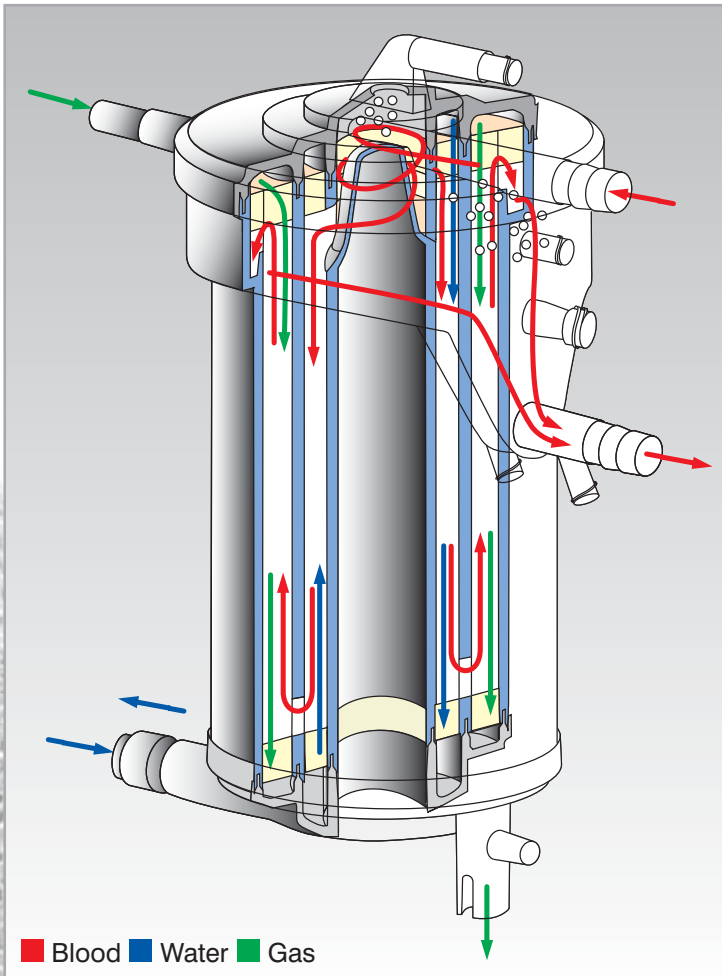

The HILITE® 7000 LT with closed hollow fibres is designed for an extended application.

Other than the microporous fibre of the HILITE® 7000, the closed fibre prevents the typical problem of plasma leakage in case of extended use.

The transfer rate per area of the closed hollow fibre is nearly identical to the microporous hollow fibre, and therefore much better compared to usual silicone membranes.

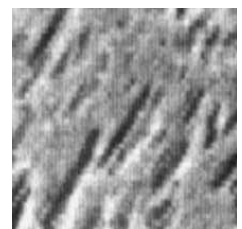
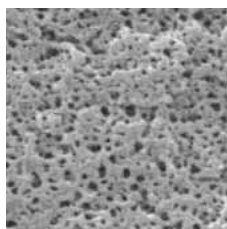
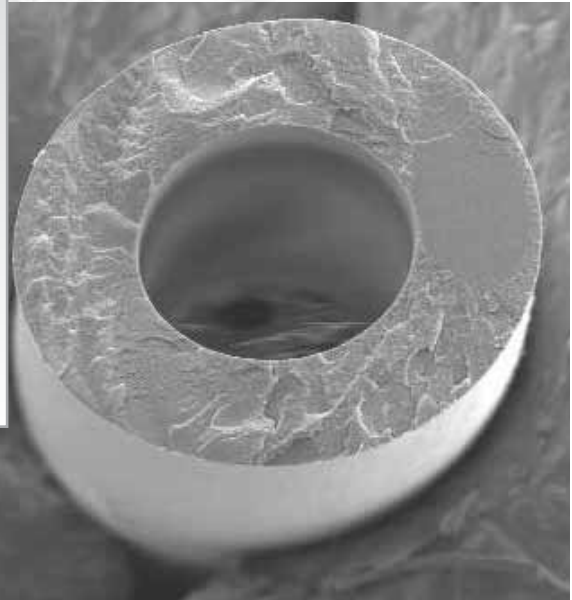

MEDOS HILITE® 7000 LT

Venous Hardshell and Cardiotomy Reservoirs for Adults

SPECIFICATIONS

CLOSED SYSTEM



MC 4040 Cardiotomy Reservoir for Adults

| | |
|--|------------------------------|
| ■ Operating volume | 300 ml - 4000 ml |
| ■ Blood flow rate | 4 l/min |
| ■ Cardiotomy filtration | 40 µm screen filter, MC 4040 |
| ■ Port configurations | |
| Filtered and defoamed ports | |
| Sucker | 6 x 1/4" - 3/8" |
| Quick primes | 1 x 1/4", 1 x 3/8" |
| Luer lock | 4 x female |
| Recirculation | 1 x 1/4", 1 x DUNI |
| Non filtered and non defoamed ports | |
| Vent | 1 x 1/4" |
| Luer lock | 2 x female |
| Venous outlet | 3/8" |
| ■ Vacuum relief valve | -100 mmHg |

MS Venous Softbag Reservoir for Adults

| | |
|--------------------------------|-----------------------------|
| ■ Maximum volume | 800 ml |
| ■ Recommended flow rate | 1-7 l/min |
| ■ Bubble trap | |
| Material | Polyester screen |
| Filtration | 185 µm |
| ■ Ports | depending on reservoir type |

MVC 4030 Venous Hardshell Reservoir for Adults

| | |
|---|-------------------------------|
| ■ Operating volume | 300 ml - 4000 ml |
| ■ Blood flow rate | |
| Venous section | up to 7 l/min |
| Cardiotomy section | up to 4 l/min |
| Maximum total flow | up to 7 l/min |
| ■ Cardiotomy filtration | 30 µm screen filter, MVC 4030 |
| ■ Port configurations | |
| Venous section defoamed ports | |
| Venous inlet | 1/2", 360° rotatable |
| Luer lock | 2 x female |
| Cardiotomy section filtered and defoamed ports | |
| Sucker | 6 x 1/4" - 3/8" |
| Quick primes | 1 x 1/4", 1 x 3/8" |
| Luer lock | 4 x female |
| Recirculation | 1 x 1/4", 1 x DUNI |
| Non filtered and non defoamed ports | |
| Vent | 1 x 1/4" |
| Luer lock | 2 x female |
| Venous outlet | 3/8" |
| ■ Temperature port | at the venous inlet port |
| ■ Vacuum relief valve | -100 mmHg |

OPEN SYSTEM



MEDOS HILITE® 7000 LT

Performance Data of HILITE® 7000 LT Hollow Fibre Oxygenator with Diffusion Membrane for Adults

PERFORMANCE DATA

SPECIFICATIONS

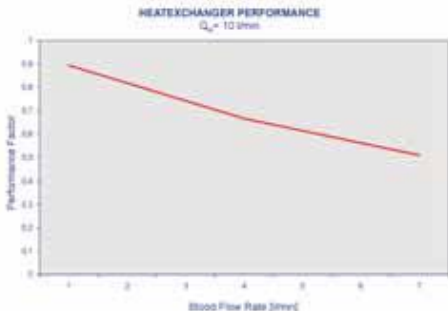
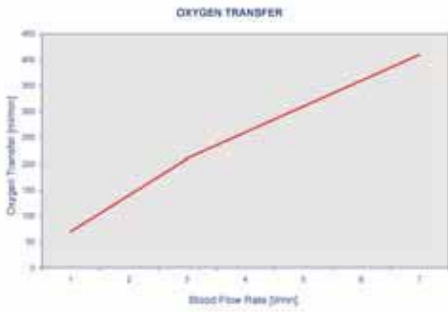
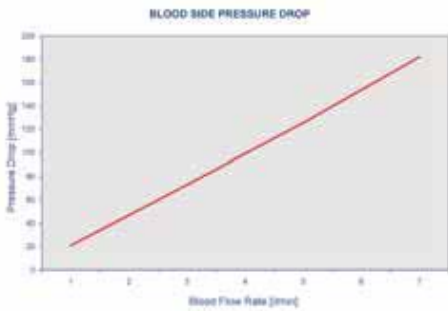

Test conditions in accordance to the AAMI standard by usage of bovine blood

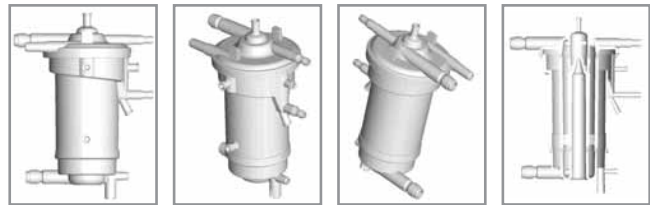

- **Blood flow rate** 1-7 l/min
- **Static priming volume** 275 ml
- **Gas exchanger**
 - Material: Polymethylpentene
 - Type: Plasma tight hollow fibre
 - OD: 380 μm
 - Surface: 1.9 m²
- **Heat exchanger**
 - Material: Polyester
 - Type: Hollow fibre
 - Surface: 0.45 m²
- **Port configurations**
 - Blood inlet/outlet: 3/8", 3/8"
 - Gas inlet/outlet: 1/4", 3/8"
 - Water inlet/outlet: 3/8" Hansen type coupling
 - Recirculation, arterial: Quick connection DIN EN 1283 Luer lock female
 - Cardioplegia: Quick connection DIN EN 1283
 - Blood sample, arterial: Luer lock female
 - Temperature, arterial: Luer lock female
 - Vent, venous: Luer lock female

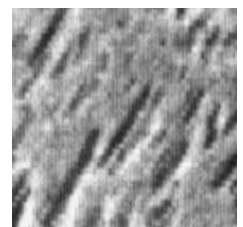
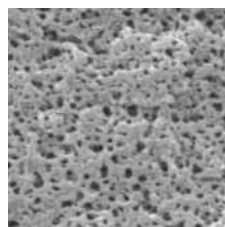

MEDOS HILITE® 2400 LT and 800 LT

Hollow Fibre Oxygenator with Diffusion Membrane for Paediatrics and Infants



Based on the established technology of the HILITE® 7000 Oxygenator, two smaller versions were developed for the special requirements of Paediatrics and Infants. The outstanding technology ensures safe and reliable functionality and efficiency.

- Outstanding gas transfer
- Low priming volume
- Excellent blood and air handling
- Integrated heat exchanger

In addition to these features we have implemented innovative state of the art technologies.

The user can choose between a microporous fibre and the closed fibre for an extended application.

Furthermore, an increased flow range offers a higher level of flexibility and safety for a wide range of applications.

Finally, all versions can be treated with RHEOPARIN®, the MEDOS Heparin Coating.



MEDOS HILITE® 2400 LT and 800 LT

Hollow Fibre Oxygenator with Diffusion Membrane for Paediatrics and Infants



1. Blood inlet
2. Recirculation
3. Blood outlet
4. Blood sample, arterial
5. Gas outlet
6. Water inlet
7. Water outlet
8. Gas inlet
9. Vent port, venous
10. Temperature, arterial
11. Port to remove remaining blood

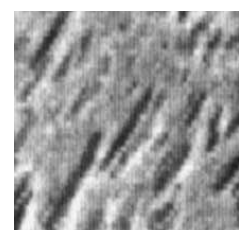
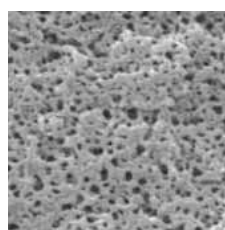
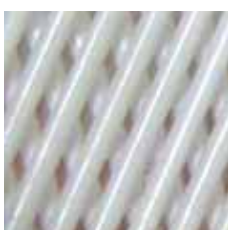

MEDOS HILITE® 2400 LT and 800 LT

Venous Hardshell and Cardiotomy Reservoirs for Paediatrics and Infants

SPECIFICATIONS



Venous Hardshell Reservoir for Paediatrics and Infants

| | Paediatric | Infant |
|--|---------------------------|---------------------------|
| ■ Operating volume | 50 ml - 1600 ml | 50 ml - 700 ml |
| ■ Blood flow rate | | |
| Venous section | 3 l/min | 1.2 l/min |
| Cardiotomy section | 2 l/min | 0.9 l/min |
| ■ Cardiotomy filtration | 30 µm, MVC 1630 | 30 µm, MVC 0730 |
| ■ Port configurations | | |
| Venous section defoamed ports | | |
| Venous inlet | 3/8" | 1/4" |
| Luer lock | 2 x female | 2 x female |
| Cardiotomy section, filtered and defoamed ports | | |
| Sucker | 4 x 3/16" - 1/4", 2x 1/4" | 4 x 3/16" - 1/4", 2x 1/4" |
| Quick prime | 1 x 1/4" | 1 x 1/4" |
| Luer lock | 4 x female | 4 x female |
| Non filtered and non defoamed ports | | |
| Vent | 1 x 1/4" | 1 x 1/4" |
| Luer lock | 2 x female | 2 x female |
| Venous outlet | 1/4" | 3/16" - 1/4" |
| ■ Temperature port | at the venous inlet port | at the venous inlet port |
| ■ Vacuum relief valve | -100 mmHg | -100 mmHg |

Venous Softbag Reservoir for Paediatrics and Infants

| | |
|--------------------------------|-----------------------------|
| ■ Maximum volume | 350 ml |
| ■ Minimum volume | 40 ml |
| ■ Recommended flow rate | 1-3 l/min |
| ■ Bubble trap | |
| Material | Polyester screen |
| Filtration | 185 µm |
| ■ Ports | depending on Reservoir type |

Cardiotomy Reservoir for Paediatrics and Infants

| | Paediatric | Infant |
|--|----------------------------|----------------------------|
| ■ Operating volume | 50 ml - 1600 ml | 50 ml - 700 ml |
| ■ Blood flow rate | 2 l/min | 0.9 l/min |
| ■ Cardiotomy filtration | 40 µm, MC 1640 | 40 µm, MC 0740 |
| ■ Port configurations | | |
| Filtered and defoamed ports | | |
| Sucker | 4 x 3/16" - 1/4", 2 x 1/4" | 4 x 3/16" - 1/4", 2 x 1/4" |
| Quick prime | 1 x 1/4" | 1 x 1/4" |
| Luer lock | 4 x female | 4 x female |
| Non filtered and non defoamed ports | | |
| Vent | 1 x 1/4" | 1 x 1/4" |
| Luer lock | 2 x female | 2 x female |
| Venous outlet | 1/4" | 3/16" - 1/4" |
| ■ Vacuum relief valve | -100 mmHg | -100 mmHg |

MEDOS HILITE® 2400 LT

Performance Data of HILITE® 2400 LT Hollow Fibre Oxygenator with Diffusion Membrane for Paediatrics

PERFORMANCE DATA

SPECIFICATIONS

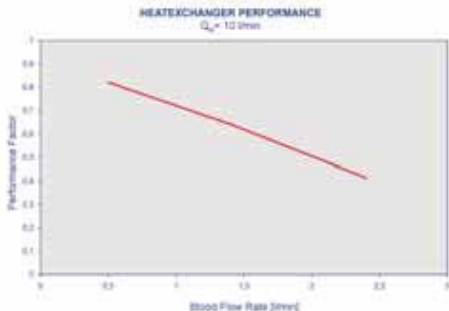
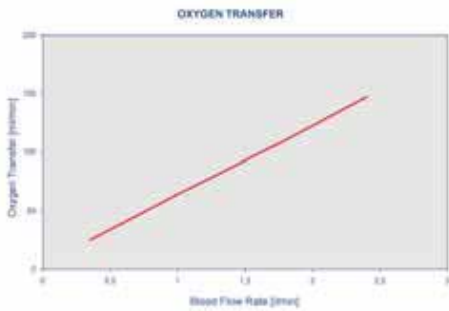
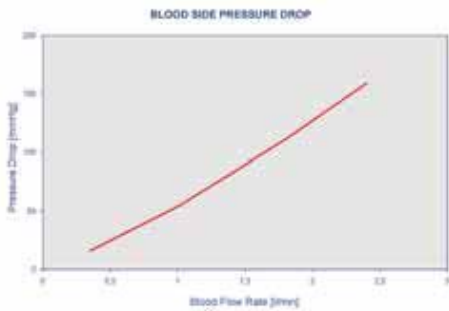

Test conditions in accordance to the AAMI standard by usage of bovine blood

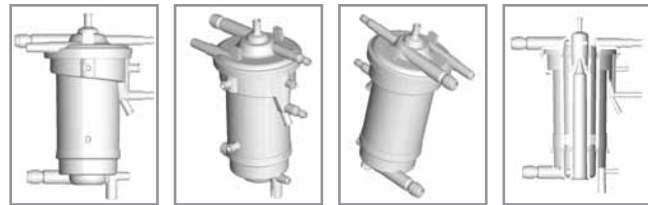

| | |
|---------------------------------|---------------------------|
| ■ Blood flow rate | 2.4 l/min |
| ■ Static priming volume | 95 ml |
| ■ Gas exchanger | |
| Material: | Polymethylpentene |
| Type: | Plasma tight hollow fibre |
| ID/OD: | 200/380 μm |
| Surface: | 0.65 m^2 |
| ■ Heat exchanger | |
| Material: | Polyester |
| Type: | Hollow fibre |
| Surface: | 0.16 m^2 |
| Heat exchanger performance: | 63% |
| ■ Port configuration | |
| Blood inlet/outlet: | 1/4", 1/4" |
| Gas inlet/outlet: | 1/4", 3/8" |
| Water inlet/outlet: | 1/4" Hansen type coupling |
| Recirculation, arterial: | Luer lock female |
| Blood sample, arterial: | Luer lock female |
| Temperature, arterial: | Luer lock female |
| Vent, venous: | Luer lock female |
| Port to remove remaining blood: | Luer lock female |

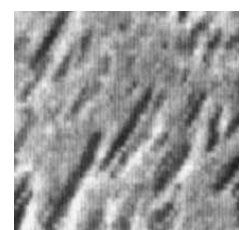
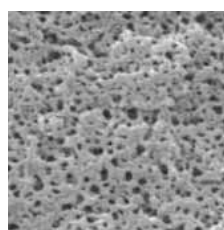

MEDOS HILITE® 800 LT

Performance Data of HILITE® 800 LT Hollow Fibre Oxygenator with Diffusion Membrane for Infants

PERFORMANCE DATA

SPECIFICATIONS

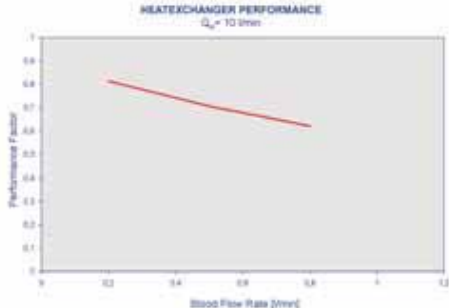
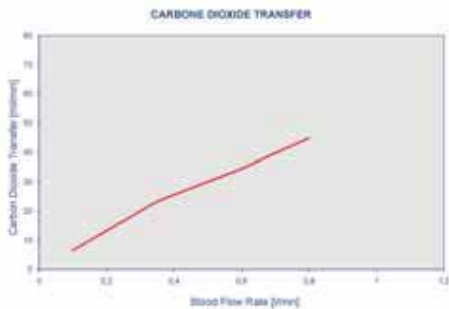
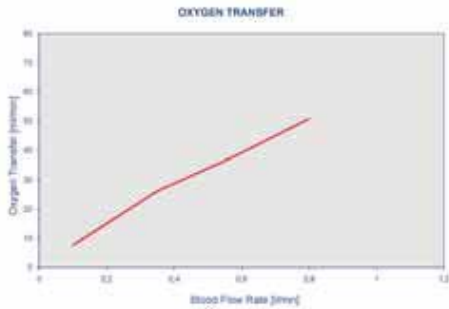
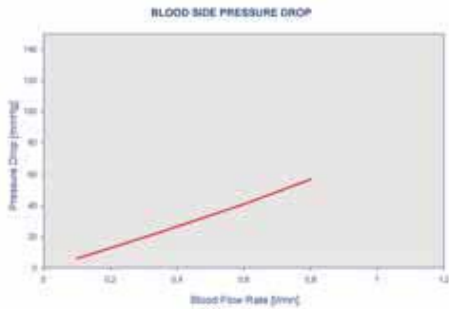

Test conditions in accordance to the AAMI standard by usage of bovine blood

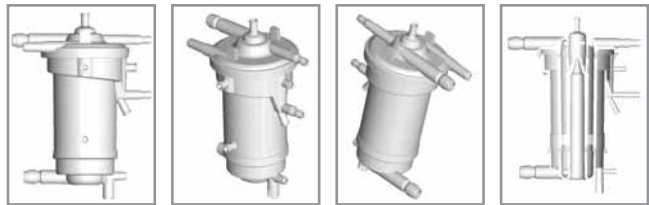

- **Blood flow rate** 0.8 l/min
- **Static priming volume** 55 ml
- **Gas exchanger**
 - Material: Polymethylpentene
 - Type: Plasma tight hollow fibre
 - ID/OD: 200/380 μm
 - Surface: 0.32 m^2
- **Heat exchanger**
 - Material: Polyester
 - Type: Hollow fibre
 - Surface: 0.074 m^2
 - Heat exchanger performance: 63%
- **Port configurations**
 - Blood inlet/outlet: 1/4" - 3/16", 1/4" - 3/16"
 - Gas inlet/outlet: 1/4", 1/4"
 - Water inlet/outlet: 1/4" Hansen type coupling
 - Recirculation, arterial: Luer lock female
 - Blood sample, arterial: Luer lock female
 - Temperature, arterial: Luer lock female
 - Vent, venous: Luer lock female
 - Port to remove remaining blood: Luer lock female



MEDOS HILITE® 7000 LT

Hollow Fibre Oxygenator with Diffusion Membrane for Adults

ORDERING INFORMATION

PRODUCT

OXYGENATORS FOR ADULTS

**HILITE® 7000 LT Hollow Fibre Oxygenator
blood inlet/outlet opposite**

ME 6202 0L01

**HILITE® 7000 LT Hollow Fibre Oxygenator
blood inlet/outlet same side**

ME 6202 0L61

**HILITE® 7000 LT System
including HILITE® 7000 LT Hollow Fibre Oxygenator ME 6202 0L01
with adapted HILITE® MVC 4030 Venous Hardshell Reservoir**

ME 6202 0L02

**HILITE® 7000 LT System
including HILITE® 7000 LT Hollow Fibre Oxygenator ME 6202 0L61
with adapted HILITE® MVC 4030 Venous Hardshell Reservoir**

ME 6202 0L62

HOLDER

Holder for HILITE® 7000 Hollow Fibre Oxygenator

ME ZH 0000

**Holder for HILITE® 7000 Hollow Fibre Oxygenator with
adapted HILITE® MVC 4030 Venous Hardshell Reservoir**

ME ZH 0018

FITTINGS

Stop arm middle piece, h 30 mm for greater flexibility, length to 60 mm

ME ZHMT 0030

Stop arm middle piece, h 40 mm for greater flexibility, length to 150 mm

ME ZHMT 0040

Holder for stopcock manifold

ME ZHHB 0080

Water coupling for Hollow Fibre Oxygenator with tubing connector, straight

ME ZW02 0005

Water coupling for Hollow Fibre Oxygenator with tubing connector, 90° bend

ME ZW02 0006

Temperature Probe

ME 4700

CE
0481

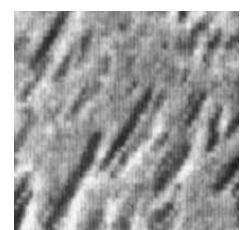
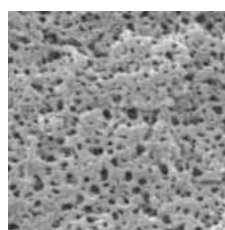

MEDOS HILITE® 2400 LT and 800 LT

Hollow Fibre Oxygenator with Diffusion Membrane for Paediatrics and Infants

ORDERING INFORMATION

PRODUCT

CODE

OXYGENATORS FOR PAEDIATRICS AND INFANTS

**HILITE® 2400 LT Paediatric Hollow Fibre Oxygenator
with leakage tight hollow fibre**

ME 6205 0L01

**HILITE® 800 LT Infant Hollow Fibre Oxygenator
with leakage tight hollow fibre**

ME 6208 0L01

**HILITE® 2400 LT System for Paediatrics
including HILITE® 2400 LT Hollow Fibre Oxygenator ME 6205 0L01
with adapted HILITE® MVC 1630 Venous Hardshell Reservoir**

ME 6205 0L02

**HILITE® 800 LT System for Infants
including HILITE® 800 LT Hollow Fibre Oxygenator ME 6208 0L01
with adapted HILITE® MVC 0730 Venous Hardshell Reservoir**

ME 6208 0L02

HOLDER

Holder for HILITE® Paediatric and Infant Oxygenators

ME ZH 0502

Holder for HILITE® Paediatric and Infant Oxygenation Systems

ME ZH0R 5002

FITTINGS

**Water coupling for HILITE® Paediatric and Infant Oxygenators,
tubing connector, straight**

ME ZW05 0005

**Water coupling for HILITE® Paediatric and Infant Oxygenators,
tubing connector, 90° bend**

ME ZW05 0006

**Water coupling for HILITE® Paediatric and Infant Oxygenators,
3/8" Hansen connector, straight**

ME ZW05 0007

**Water coupling for HILITE® Paediatric and Infant Oxygenators,
3/8" Hansen connector, 90° bend**

ME ZW05 0008

Temperature Probe

ME 4700

All MEDOS Oxygenators of the HILITE® product family
can be processed with Heparin coating RHEOPARIN® CE0123

CE
0481



MEDOS HILITE® LT

Oxygenator for the extended application for Adults, Paediatrics and Infants



MEDOS Medizintechnik AG
Obere Steinfurt 8-10
D-52222 Stolberg • Germany
Phone: +49(0)2402-96 64 0
Orderingfax: +49(0)700-63 36 73 29
www.medos-ag.com • info@medos-ag.com



MEDOS
Medizintechnik AG